

# Electronic timer CT-WBS.22

## Impulse generating and flashing with 2 c/o (SPDT) contacts

The CT-WBS.22 is a multifunctional electronic timer from the CT-S range. It provides 10 timing functions and 10 time ranges.

All electronic timers from the CT-S range are available with two different terminal versions. You can choose between the proven screw connection technology (double-chamber cage connection terminals) and the completely tool-free Easy Connect Technology (push-in terminals).



2CDC 251 029 V0011

### Characteristics

- Rated control supply voltage 24-48 V DC, 24-240 V AC
- 7 timing functions:  
Flasher starting with ON, Flasher starting with OFF, Impulse-ON, ON-delay, Fixed impulse with adjustable time delay, Adjustable impulse with fixed time delay, ON/OFF-function
- 10 time ranges (0.05 s - 300 h)
- Precise adjustment by front-face operating elements
- Screw connection technology or Easy Connect Technology available
- Enclosure material for highest fire protection classification
- Tool-free mounting and demounting on DIN-rail
- 2 c/o (SPDT) contacts
- 22.5 mm (0.89 in) width
- 2 LEDs for status indication

### Approvals

- UL 508, CAN/CSA C22.2 No.14
- GL
- GOST
- CB scheme
- CCC

### Marks

- CE
- C-Tick

### Order data

#### Electronic timer

Type	Rated control supply voltage	Connection technology	Time ranges	Order code
CT-WBS.22P	24-48 V DC, 24-240 V AC	Push-in terminals	0.05 s - 300 h	1SVR 740 040 R3300
CT-WBS.22S	24-48 V DC, 24-240 V AC	Screw type terminals	0.05 s - 300 h	1SVR 730 040 R3300

#### Accessories

Type	Description	Order code
ADP.01	Adapter for screw mounting on panel	1SVR 430 029 R0100
MAR.01	Beschriftungsschild für Geräte ohne DIP-Schalter	1SVR 366 017 R0100
COV.11	Plombierbare Klarsichtabdeckung	1SVR 600 805 P0000

## Connection technology

### Maintenance free Easy Connect Technology with push-in terminals

Type designation CT-xxS.yyP

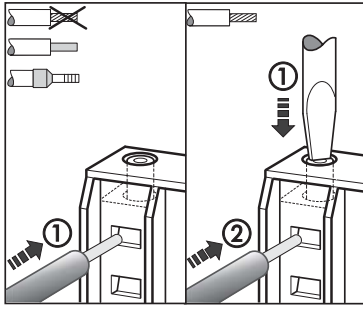

#### Push-in terminals

- Tool-free connection of rigid and flexible wires with wire end ferrule  
Wire size: 2 x 0.5-1.5 mm<sup>2</sup>
- Easy connection of flexible wires without wire end ferrule by opening the terminals
- Opening for testing the electrical contacting
- Gas-tight

### Approved screw connection technology with double-chamber cage connection terminals

Type designation CT-xxS.yyS

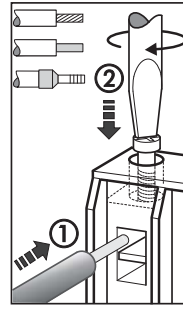

#### Double-chamber cage connection terminals

- Terminal spaces for different wire sizes:  
fine-strand with/without wire end ferrule:  
1 x 0.5-2.5 mm<sup>2</sup>, 2 x 0.5-1.5 mm<sup>2</sup>  
rigid: 1 x 0.5-4 mm<sup>2</sup>, 2 x 0.5-2.5 mm<sup>2</sup>
- Pozidrive screws for pan- or crosshead screwdrivers

Both the Easy Connect Technology with push-in terminals and screw connection technology with double-chamber cage connection terminals have the same connection geometry as well as terminal position.

## Functions

### Operating controls and terminals

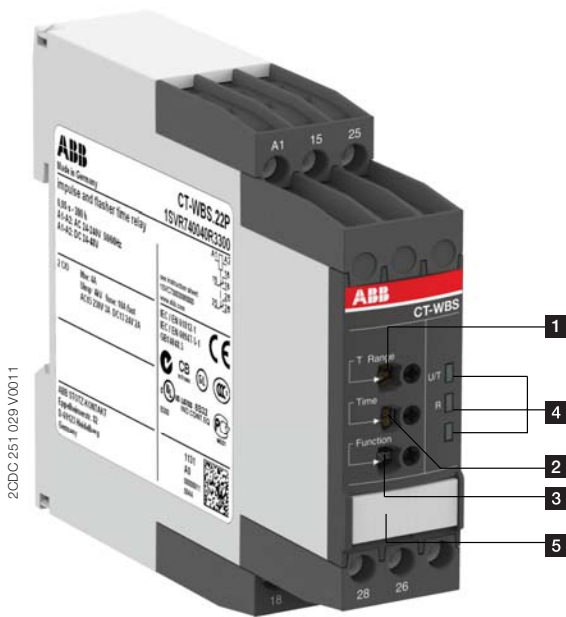

- 1 Rotary switch for the preselection of the time range
- 2 Fine adjustment of the time delay
- 3 Rotary switch for the preselection of the timing function
- 4 Indication of operational states  
U: green LED - control supply voltage / timing  
R: yellow LED -output relays energized
- 5 Marker label

### Application

The CT-S range timers are designed for use in industrial applications. They operate over a universal range of supply voltages and a large time delay range, within compact dimensions. The easy-to-set front-face potentiometers, with direct reading scales, provide accurate time delay adjustment.

Multifunction timers are ideally suited for service and maintenance applications, because one device can replace a number of time relays with different functions, voltage and time ranges. This reduces inventory and saves money.

### Operating mode

The CT-WBS.22 with 2 c/o (SPDT) contacts offers 7 timing functions. The function is rotary switch selectable on the front of the unit. Each function is indicated by an international function symbol.

One of 10 time ranges, from 0.05 s to 300 h, can be selected with an other rotary switch. The fine adjustment of the time delay is made via an internal potentiometer, with a direct reading scale, on the front of the unit.

Timing is displayed by a flashing green LED labelled U/T.

## Function diagram

### ON-delay

This function requires continuous control supply voltage for timing.

Timing begins when control supply voltage is applied. The green LED flashes during timing. When the selected time delay is complete, the output relay energizes and the flashing green LED turns steady.

If control supply voltage is interrupted, the output relay de-energizes and the time delay is reset.

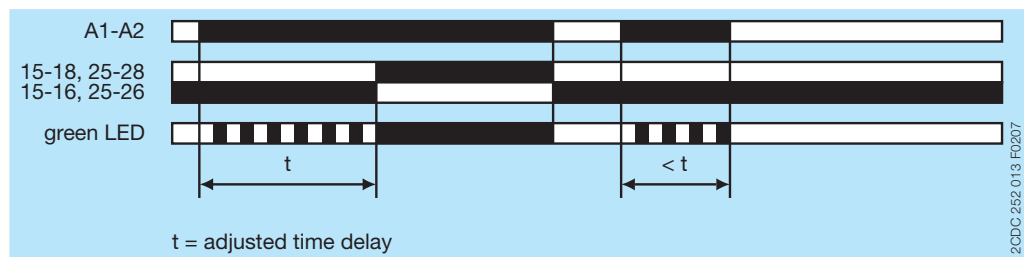

### Impulse-ON

This function requires continuous control supply voltage for timing.

The output relay energizes immediately when control supply voltage is applied and de-energizes after the set pulse time is complete. The green LED flashes during timing. When the selected pulse time is complete, the flashing green LED turns steady.

If control supply voltage is interrupted, the output relay de-energizes and the time delay is reset.

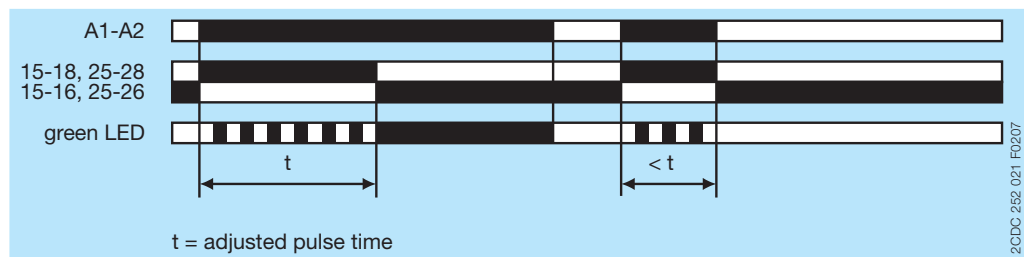

### Flasher, starting with ON

Applying control supply voltage starts timing with symmetrical ON / OFF times. The cycle starts with an ON time first. The ON / OFF times are displayed by the flashing green LED, which flashes twice as fast during the OFF time.

If control supply voltage is interrupted, the output relay de-energizes and the time delay is reset.

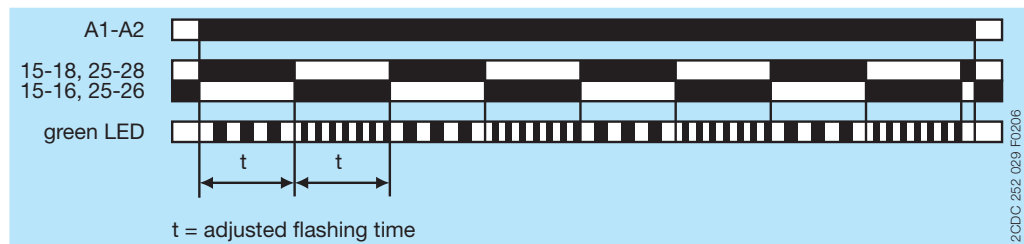

### Flasher, starting with OFF

Applying control supply voltage starts timing with symmetrical ON / OFF times. The cycle starts with an OFF time first. The ON / OFF times are displayed by the flashing green LED, which flashes twice as fast during the OFF time.

If control supply voltage is interrupted, the output relay de-energizes and the time delay is reset.

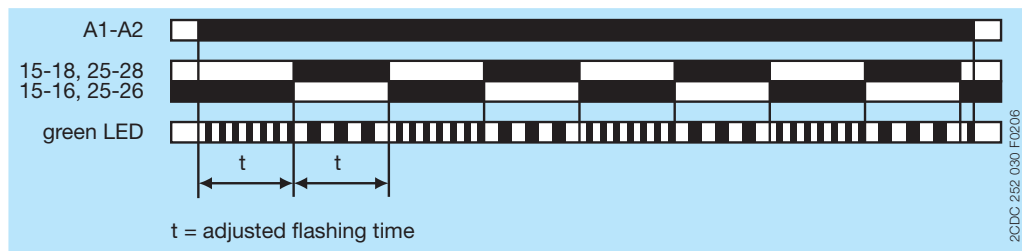

### Fixed impulse with adjustable time delay

This function requires continuous control supply voltage for timing.

The time delay  $t_1$  starts when control supply voltage is applied. The green LED flashes during timing. When  $t_1$  is complete, the output relay energizes for the fixed impulse time  $t_2$  of 500 ms and the flashing green LED turns steady.

If control supply voltage is interrupted, the time delay is reset. The output relay does not change state.

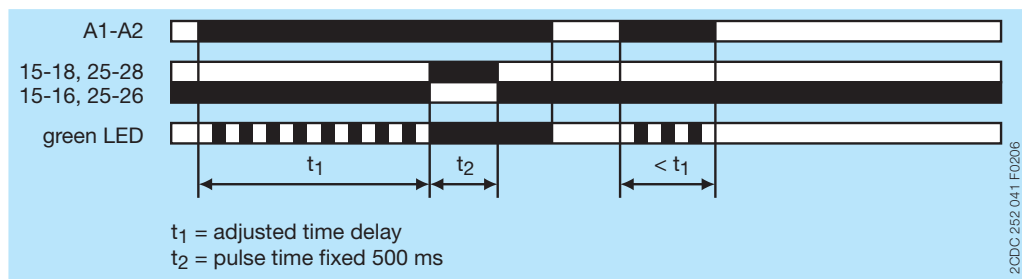

### Adjustable impulse with fixed time delay

This function requires continuous control supply voltage for timing.

Applying control supply voltage starts the fixed time delay  $t_2$  of 500 ms. When  $t_2$  is complete, the output relay energizes and the selected pulse time  $t_1$  starts. The green LED flashes during timing. When  $t_1$  is complete, the output relay de-energizes and the flashing green LED turns steady.

If control supply voltage is interrupted, the pulse time is reset. The output relay does not change state.

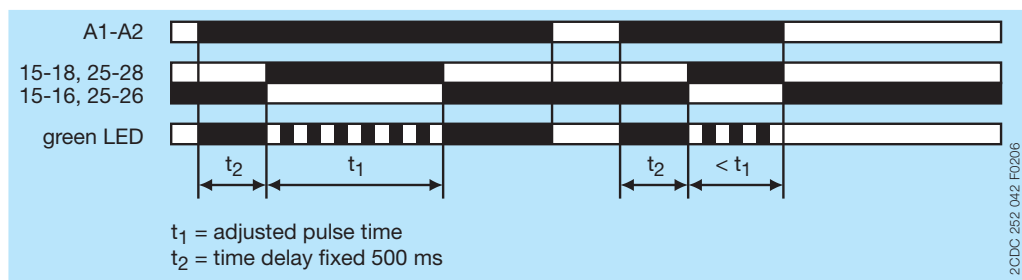

### ON/OFF-function

This function is used for test purposes during commissioning and troubleshooting.

If the selected max. value of the time range is smaller than 300 h (front-face potentiometer “Time sector” not 300 h), applying control supply voltage energizes the output relay immediately and the green LED glows. Interrupting control supply voltage, de-energizes the output relay.

If the selected max. value of the time range is 300 h (front-face potentiometer “Time sector” = 300 h) and control supply voltage is applied, the green LED glows, but the output relay does not energize.

Time settings and operating of the control inputs have no effect on the operation.

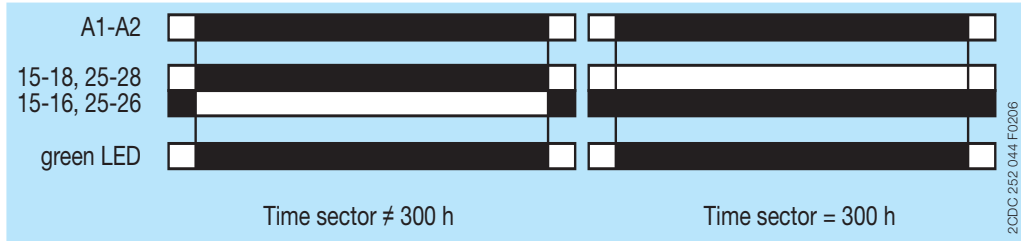

### Electrical connection

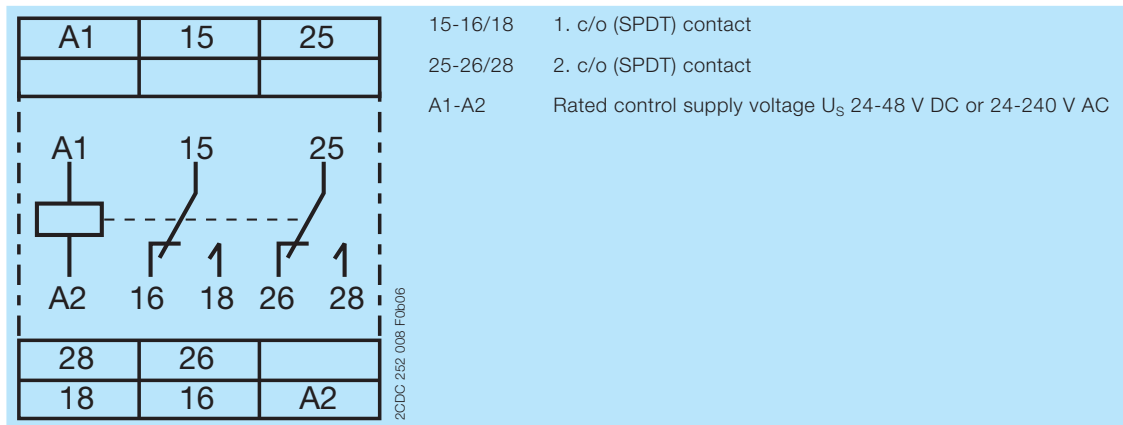

Connection diagram



## Technical data

Data at  $T_a = 25\text{ °C}$  and rated values, unless otherwise indicated

### Input circuits

Supply circuit		A1-A2		
Rated control supply voltage $U_s$		24-48 V DC, 24-240 V AC		
Rated control supply voltage $U_s$ tolerance	24-48 V DC	-15...+10 %		
	24-240 V AC	-15...+10 %		
Rated frequency	DC	n/a		
	AC	50/60 Hz		
Frequency range	AC	47-63 Hz		
Typical current / power consumption		<b>24 V DC</b>	<b>230 V AC</b>	<b>115 V AC</b>
	24-48 V DC	16 mA / on request	- / -	- / -
	24-240 V AC	- / -	60 mA / on request	36 mA / on request
Power failure buffering time	24 V DC	min. 15 ms		
	230 V AC	min. 20 ms		
Timing circuit				
Kind of timer	Impulse and flasher timer	Flasher, starting with ON Flasher, starting with OFF Impulse-ON ON-delay Fixed impulse with adjustable time delay Adjustable impulse with fixed time delay ON/OFF-function		
Time ranges	0.05 s - 300 h	0.05-1 s, 0.15-3 s, 0.5-10 s, 1.5-30 s, 5-100 s, 15-300 s, 1.5-30 min, 15-300 min, 1.5-30 h, 15-300 h		
Recovery time		< 80 ms		
Repeat accuracy (constant parameters)		$\Delta t < \pm 0.2\%$		
Accuracy within the rated control supply voltage tolerance		$\Delta t < 0.004\%/V$		
Accuracy within the temperature range		$\Delta t < 0.03\%/^{\circ}C$		

### User interface

Indication of operational states		
Control supply voltage / timing	U/T: green LED	 : control supply voltage applied
	U/T: green LED	 : timing
Relay status	R: yellow LED	 : output relay energized

## Output circuits

Kind of output	15-16/18	Relay, 1 c/o (SPDT) contact
	25-26/28	Relay, 2 c/o (SPDT) contact
Contact material		Cd-free
Rated operational voltage $U_e$		250 V
Minimum switching voltage / Minimum switching current		12 V / 10 mA
Maximum switching voltage / Minimum switching current		see 'Load limit curves' on page 8
Rated operational current $I_e$ (IEC/EN 60947-5-1)	AC12 (resistive) at 230 V	4 A
	AC15 (inductive) at 230 V	3 A
	DC12 (resistive) at 24 V	4 A
	DC13 (inductive) at 24 V	2 A
AC rating (UL 508)	utilization category (Control Circuit Rating Code)	B 300
	max. rated operational voltage	300 V AC
	max. continuous thermal current at B 300	5 A
	max. making / breaking apparent power at B 300	3600/360 VA
Mechanical lifetime		30 x 10 <sup>6</sup> switching cycles
Electrical lifetime	AC12, 230 V, 4 A	0.1 x 10 <sup>6</sup> switching cycles
Maximum fuse rating to achieve short-circuit protection (IEC/EN 60947-5-1)	n/c contact	6 A fast-acting
	n/o contact	10 A fast-acting

## General data

MTBF		on request
Duty time		100 %
Dimensions (W x H x D)	product dimensions	22.5 x 85.6 x 103.7 mm (0.89 x 3.37 x 4.08 in)
	packaging dimensions	97 x 109 x 30 mm (3.82 x 4.29 x 1.18 in)
Weight	net weight	
	gross weight	
Mounting		DIN rail (IEC/EN 60715), snap-on mounting without any tool
Mounting position		any
Minimum distance to other units	vertical	not necessary
	horizontal	not necessary
Degree of protection	enclosure	IP50
	terminals	IP20

## Electrical connection

		Screw connection technology	Easy Connect Technology (Push-in)
Wire size	fine-strand with wire end ferrule	1 x 0.5-2.5 mm <sup>2</sup> (1 x 20-14 AWG)	2 x 0.5-1.5 mm <sup>2</sup> (2 x 20-16 AWG)
		2 x 0.5-1.5 mm <sup>2</sup> (2 x 20-16 AWG)	
	fine-strand without wire end ferrule	1 x 0.5-2.5 mm <sup>2</sup> (1 x 20-14 AWG)	2 x 0.5-1.5 mm <sup>2</sup> (2 x 20-16 AWG)
2 x 0.5-1.5 mm <sup>2</sup> (2 x 20-16 AWG)			
	rigid	1 x 0.5-4 mm <sup>2</sup> (1 x 20-12 AWG)	2 x 0.5-1.5 mm <sup>2</sup> (2 x 20-16 AWG)
		2 x 0.5-2.5 mm <sup>2</sup> (2 x 20-14 AWG)	
Stripping length		8 mm (0.32 in)	
Tightening torque		0.6 - 0.8 Nm (5.31 - 7.08 lb.in)	-



## Environmental data

Ambient temperature ranges	operation	-25...+60 °C
	storage	-40...+85 °C
Damp heat, cyclic (IEC/EN 60068-2-30)		6 x 24 h cycle, 55 °C, 95 % RH
Vibration, sinusoidal (IEC/EN 60068-2-6)	functioning	40 m/s <sup>2</sup> , 10-58/60-150 Hz
	resistance	60 m/s <sup>2</sup> , 10-58/60-150 Hz, 20 cycles
Vibration, seismic (IEC/EN 60068-3-3)	functioning	20 m/s <sup>2</sup>
Shock, half-sine (IEC/EN 60068-2-27)	functioning	100 m/s <sup>2</sup> , 11 ms, 3 shocks/direction
	resistance	300 m/s <sup>2</sup> , 11 ms, 3 shocks/direction

## Isolation data

Rated insulation voltage U <sub>i</sub>	output circuit 1 / output circuit 2	300 V
	input circuit / output circuit	500 V
Rated impulse withstand voltage U <sub>imp</sub> between all isolated circuits (IEC/EN 60664-1, VDE 0110)		4 kV; 1.2/50 µs
Power-frequency withstand voltage test between all isolated circuits (test voltage)		routine test: 2.0 kV; 50 Hz, 1 s type test: 2.5 kV; 50 Hz, 1 min
Basic insulation (IEC/EN 61140)	input circuit / output circuit	500 V
Protective separation (IEC/EN 61140; IEC/EN 50178; VDE 0106 part 101 and part 101/A1)	input circuit / output circuit	250 V
Pollution degree (IEC/EN 60664-1, VDE 0110)		3
Overvoltage category (IEC/EN 60664-1, VDE 0110)		III

## Standards

Product standard	IEC 61812-1, EN 61812-1 + A11, DIN VDE 0435 part 2021
Low Voltage Directive	2006/95/EC
EMC Directive	2004/108/EC
RoHS Directive	2002/95/EC

## Electromagnetic compatibility

Interference immunity to		IEC/EN 61000-6-1, IEC/EN 61000-6-2
electrostatic discharge	IEC/EN 61000-4-2	Level 3, 6 kV / 8 kV
radiated, radio-frequency, electromagnetic field	IEC/EN 61000-4-3	Level 3, 10 V/m (1 GHz) / 3 V/m (2 GHz) / 1 V/m (2.7 GHz)
electrical fast transient / burst	IEC/EN 61000-4-4	Level 3, 2 kV / 5 kHz
surge	IEC/EN 61000-4-5	Level 4, 2 kV A1-A2
conducted disturbances, induced by radio-frequency fields	IEC/EN 61000-4-6	Level 3, 10 V
harmonics and interharmonics	IEC/EN 61000-4-13	Level 3
Interference emission		IEC/EN 61000-6-3, IEC/EN 61000-6-4
high-frequency radiated	IEC/CISPR 22, EN 55022	Class B
high-frequency conducted	IEC/CISPR 22, EN 55022	Class B

## Technical diagrams

### Load limit curves

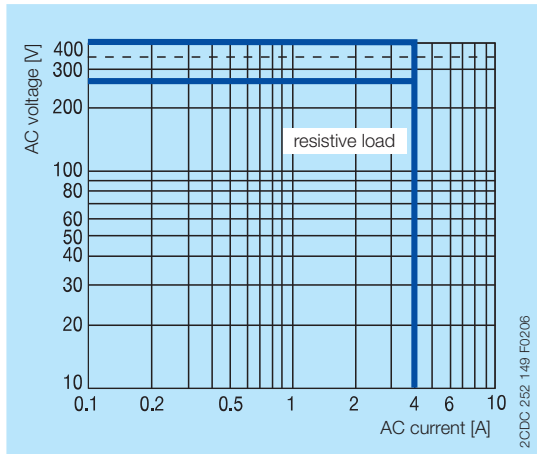

AC load (resistive)

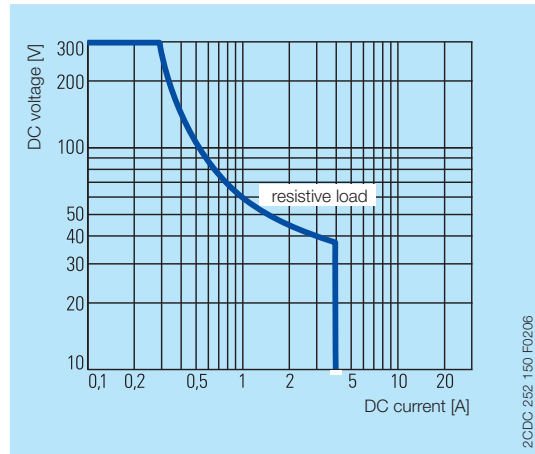

DC load (resistive)

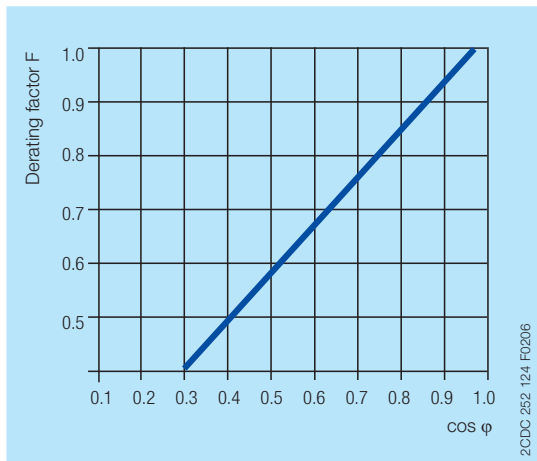

Derating factor F for inductive AC load

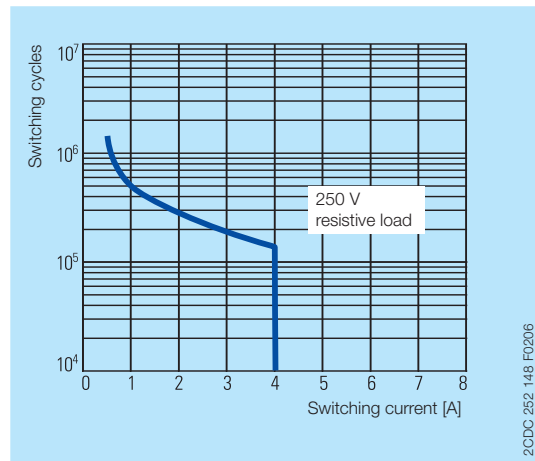

Contact lifetime

## Dimensions

in **mm** and *inches*

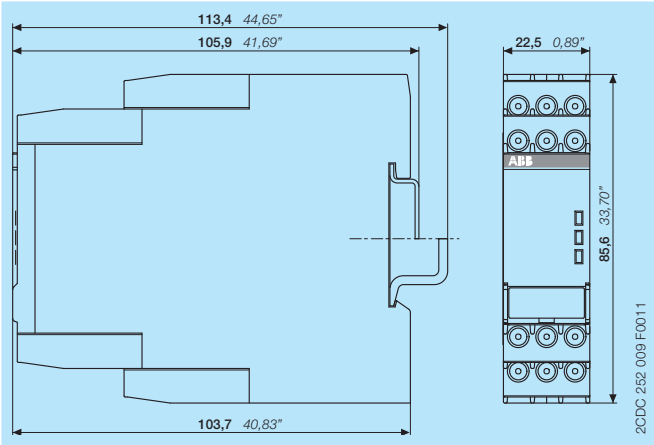

## Accessories

in **mm** and *inches*

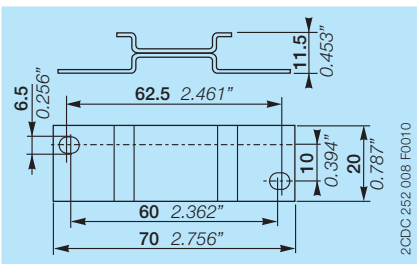

ADP.01 - Adapter for screw mounting

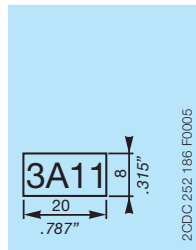

MAR.01 - Marker label

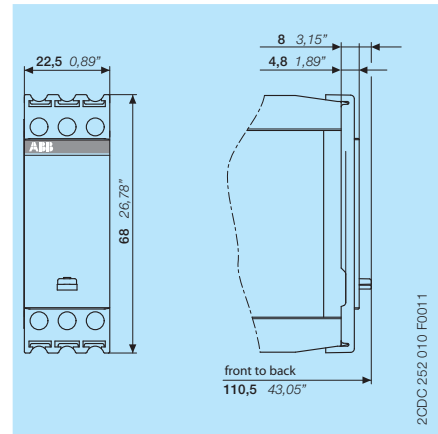

COV.11 - Sealable transparent cover

## Further documentation

Document title	Document type	Document number
Electronic Products and Relays	Technical catalogue	2CDC 110 004 C020x
CT-AHS, CT-ARS, CT-MBS, CT-MFS	Instruction manual	1SVC 730 010 M0000

You can find the documentation on the internet at [www.abb.com/lowvoltage](http://www.abb.com/lowvoltage) -> Control Products -> Electronic Relays and Controls -> Time Relays

# Contact us

## **ABB STOTZ-KONTAKT GmbH**

P. O. Box 10 16 80  
69006 Heidelberg, Germany  
Phone: +49 (0) 6221 7 01-0  
Fax: +49 (0) 6221 7 01-13 25  
E-mail: info.desto@de.abb.com

You can find the address of your  
local sales organization on the  
ABB home page  
<http://www.abb.com/contacts>  
-> Low Voltage Products and Systems

### **Note:**

We reserve the right to make technical changes or modify the contents of this document without prior notice. With regard to purchase orders, the agreed particulars shall prevail. ABB AG does not accept any responsibility whatsoever for potential errors or possible lack of information in this document.

We reserve all rights in this document and in the subject matter and illustrations contained therein. Any reproduction, disclosure to third parties or utilization of its contents – in whole or in parts – is forbidden without prior written consent of ABB AG.

Copyright© 2011 ABB  
All rights reserved